

SEZ. A-A

MDS		51J13207552GT080400	
MOTORE	MOTOR		SMAC
POTENZA	POWER	W	3000
TENSIONE BATTERIA	BATTERY VOLTAGE	Vdc	80
TENSIONE FASE	VOLTAGE ON PHASE	Vac	-
GIRI NOMINALI	RATED SPEED	rpm	3000
GIRI MASSIMI	MAX SPEED	rpm	-
COPPIA MAX	MAX TORQUE	Nm	40
CORRENTE NOMINALE	RATED CURRENT	A	39
FREQUENZA NOMINALE	RATED FREQUENCY	Hz	200 (8)
SERVIZIO	DUTY	S2	60'
PROTEZIONE	PROTECTION	IP	67
CLASSE ISOLAMENTO	INSULATION CLASS	INS	F
IMPULSI ENCODER	PULSES REVOLUTION	N°	-
FRENO EM	EM BRAKE	Nm - V	12 - 48
FRENO SERVIZIO IDRA.	IDRA. SERVICE BRAKE	Nm	-
FRENO STAZIONAMENTO	PARKING BRAKE	Nm	-
RAPPORTO	RATIO	R	1:40.61
GIRI NOMINALI IN USCITA	NOM. OUTPUT SPEED	rpm	74
GIRI MASSIMI IN USCITA	MAX OUTPUT SPEED	rpm	-
COPPIA MAX IN USCITA	MAX OUTPUT TORQUE	Nm	1000
QUANTITA' OLIO	OIL CAPACITY	cc	180
INSERIRE OLIO	OIL INSIDE		Si/Yes
TIPO OLIO	OIL TYPE		SHC 75W90
PESO	WEIGHT	kg	

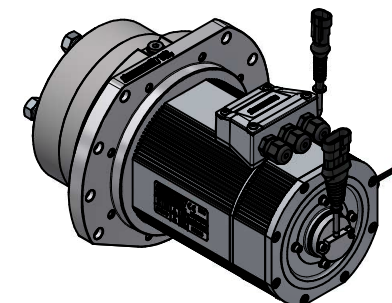
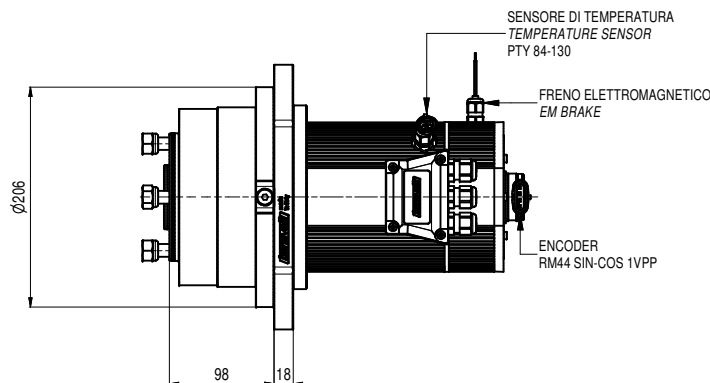

IN CASO DI DUBBIO CHIEDERE / IF IN DOUBT ASK

N°	Descrizione modifica	Data	Dis.	Pos.
1				
2				
3				

disegnato / drawn	data / date	INGOMBRO / DIMENSION		 Rubiera-Reggio Emilia-Italy www.benevelli.it
mc	06/09/2022			
controllato / checked	data / date			gruppo/group
				99
scala / scale	formato foglio / sheet size	descrizione / name		n° disegno/drawing no
1:5	A3	Motoruota WD 220 / Wheel drive WD 220		99.220.041.A.3.49
revisione / reference	n° foglio / sheet no			
00	1 / 3			